

Polarization Measurements of the D3-HeI Emission Line in Prominences

Renzo Ramelli

IRSOL, Locarno (Switzerland)

IRSOL

2. September 2003

Summary:

- Introduction
- Instrumentation
- Measurement methods
- Data analysis
- Preliminary results
- Conclusion



Introduction

- **Motivation:** improve the knowledge about the magnetic field in prominences (Hanle effect).
- Most of the theoretical works in the last two decades were based on the measurements performed at the beginning of the 80s (e.g. extensive measurements of linear polarization through filter integrating the entire emission line profile by *Leroy et al., 1984*)
- After a period with "small activity", **recent measurements** are reported in Paletou et al. (2001) and Wiehr et al. (2003)
- At **IRSOL** (Istituto Ricerche Solari Locarno) we are able to give a contribution in this field with an instrumentation very well suited for polarization measurements.

Introduction

- **Motivation:** improve the knowledge about the magnetic field in prominences (Hanle effect).
- Most of the theoretical works in the last two decades were based on the measurements performed at the beginning of the 80s (e.g. extensive measurements of linear polarization through filter integrating the entire emission line profile by *Leroy et al., 1984*)
- After a period with "small activity", **recent measurements** are reported in Paletou et al. (2001) and Wiehr et al. (2003)
- At **IRSOL** (Istituto Ricerche Solari Locarno) we are able to give a contribution in this field with an instrumentation very well suited for polarization measurements.

The Helium D3-line

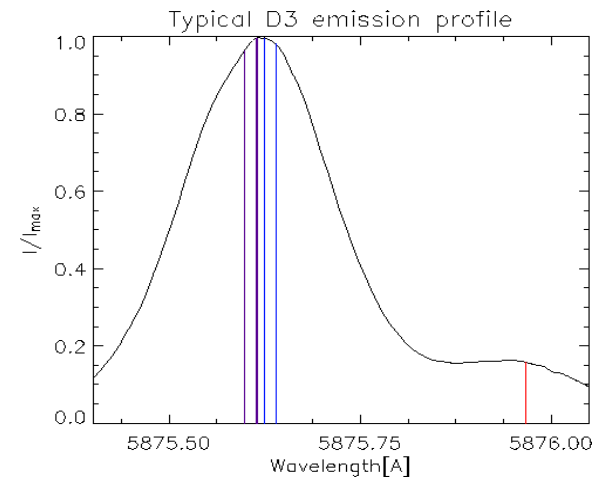
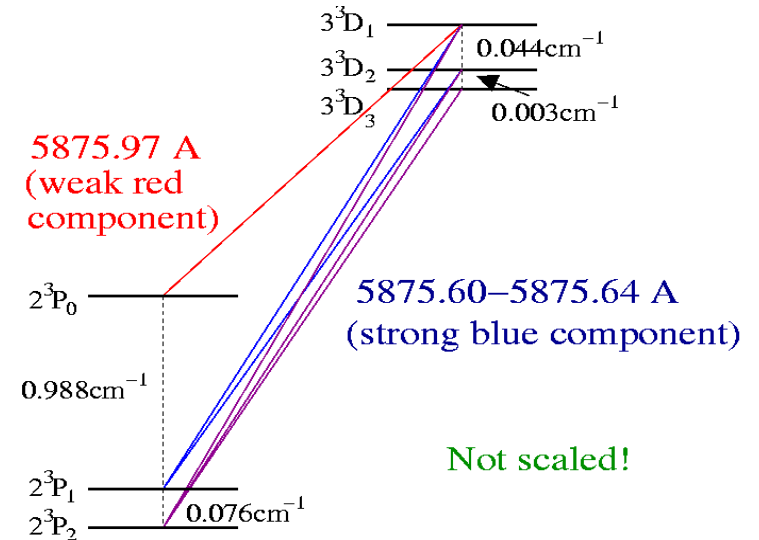

Instrumentation



- **Telescope:** Gregory - Coudé, evacuated
- Diameter of primary mirror: 45 cm
- Total focal length: 25 m



The IRSOL telescope scheme

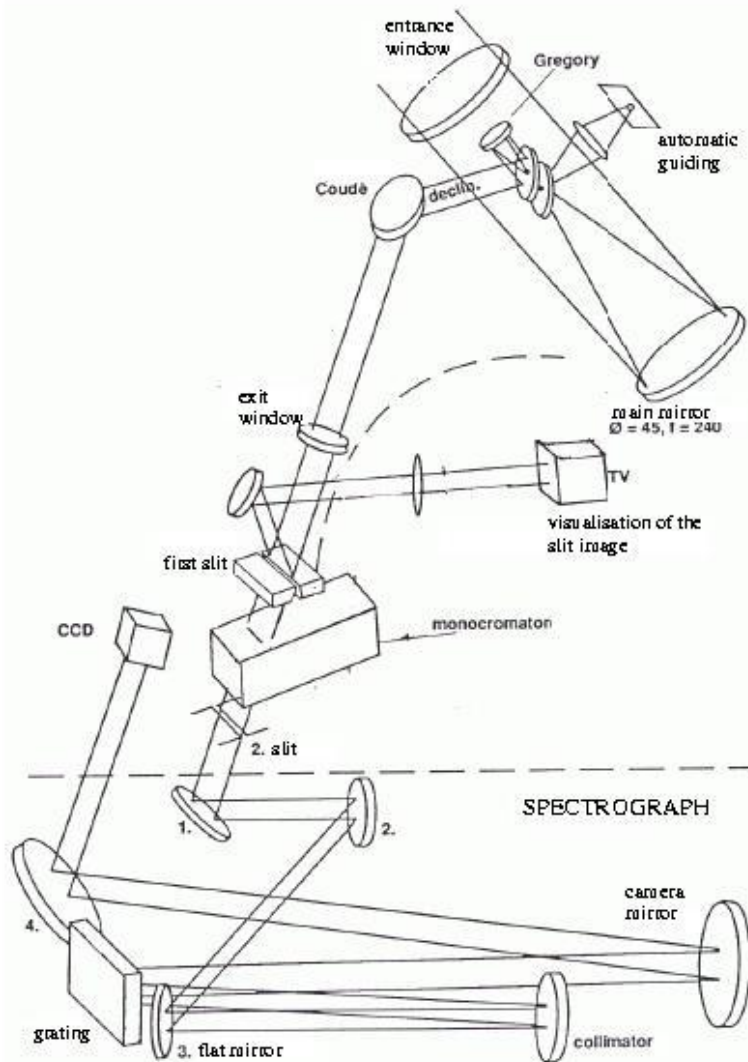

- **Spectrograph:** Czerny - Turner

- focal length: 10 m
- grating 18 cm × 36 cm
- 300 lines / mm
- blaze 63°

- **Polarimeters:**

- **Beam-exchange** polarimeter
- **ZIMPOL**-polarimeter (*Zürich Imaging Stokes Polarimeter*, developed at ETH-Zürich)

Small amount of instrumental polarization!

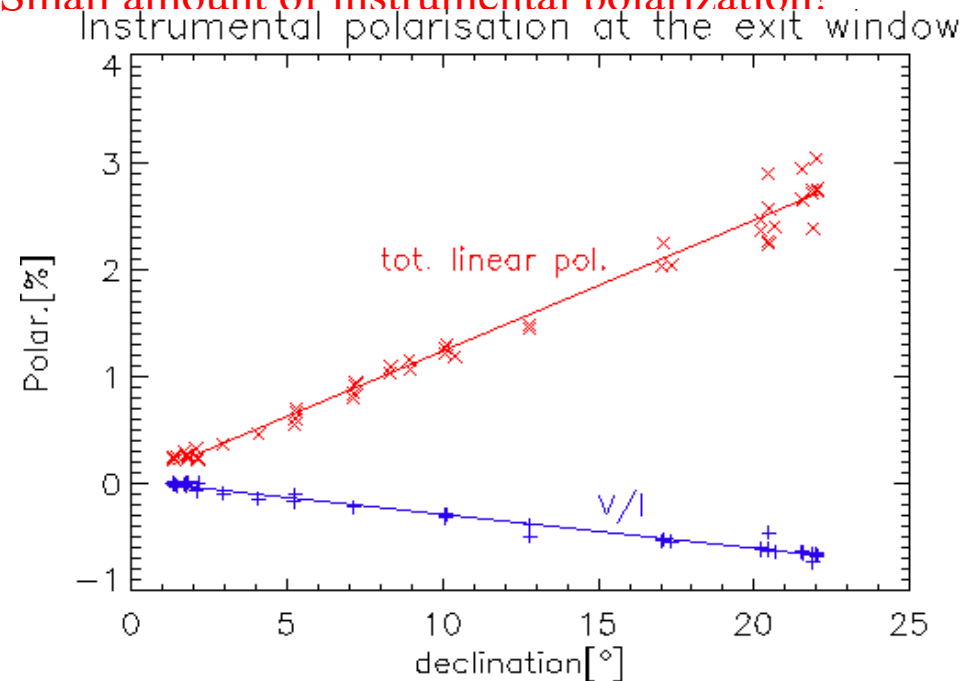

1. Measurement Method

(beam exchange technique)

The method follows the ideas of Semel et al., 1993 A&A 278, 231.

Measurement 1

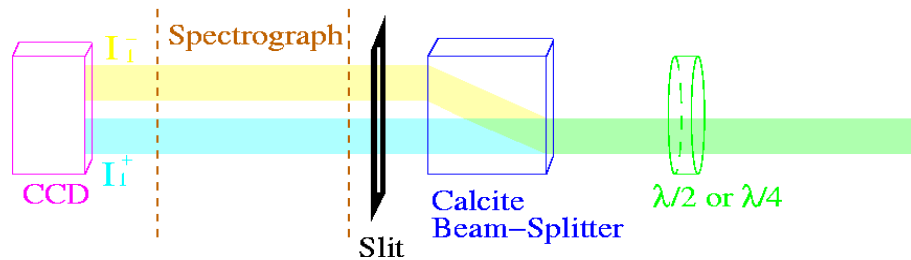

Measurement 2

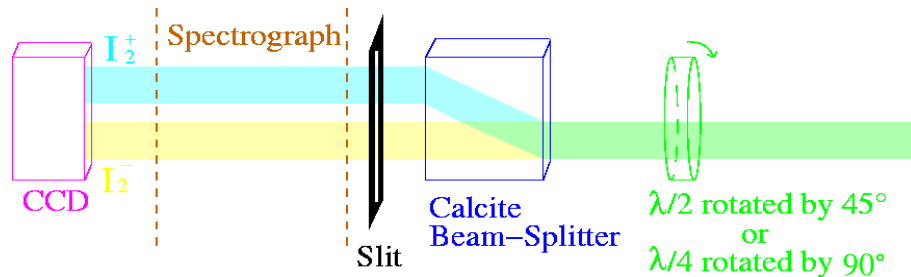

Calculation of the polarization P according to Bianda et al., 1998 A&A 331,760 allows a measurement free from effects of the detector gain table and retarder-plate transparency.

$$P = \frac{2}{F} \left[1 + F - \sqrt{1 + 2F} \right]$$

where $F = \frac{1}{2} \begin{vmatrix} I_1^+ & I_2^+ & 1 \\ I_1^- & I_2^- & 1 \end{vmatrix}$

Stokes V is measured with the $\lambda/4$ plate.

Stokes Q, U: With the $\lambda/2$ plate we measure the polarization at 0° and 45° with respect to the slit direction. Then

$$\begin{vmatrix} I_1^+ & I_2^+ & 1 \\ I_1^- & I_2^- & 1 \end{vmatrix} = \begin{vmatrix} \cos(\alpha) & \sin(\alpha) & 1 \\ \sin(\alpha) & \cos(\alpha) & 1 \end{vmatrix}$$

α depends on the position of the point observed

2. Measurement Method

with ZIMPOL II (*Zürich Imaging Stokes Polarimeter*)

ZIMPOL setup

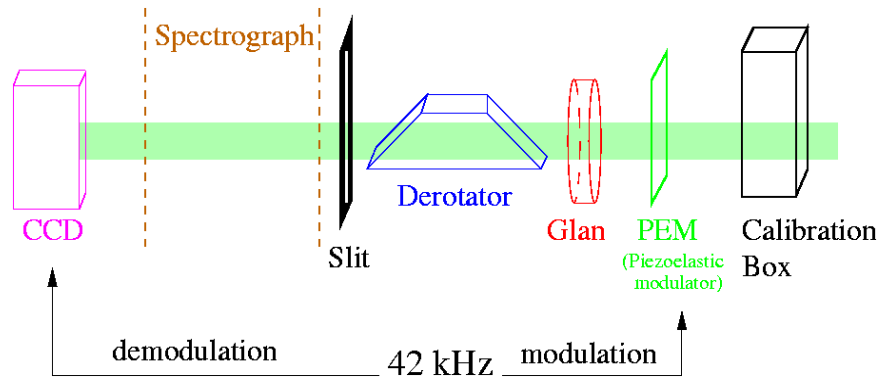

The demodulation technique

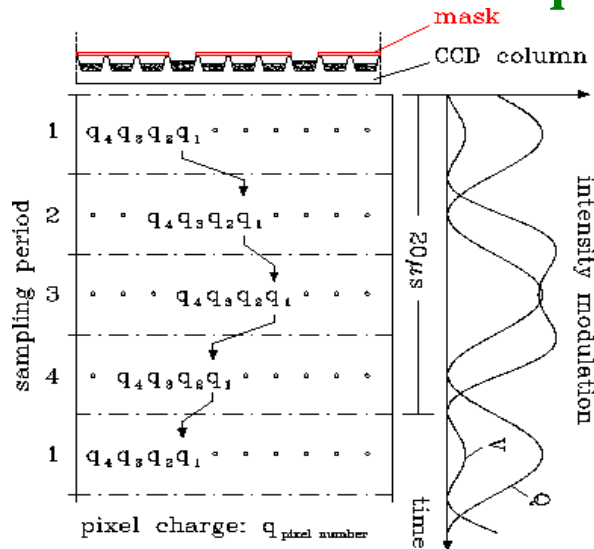

- **ZIMPOL allows polarization measurements free from seeing effects!**
- The piezoelastic modulator (PEM) introduces a time-dependent retardation.
- The transmission of the system for the different polarization states changes periodically ($\nu=42 \text{ kHz} \gg \text{seeing modulation}$).
- The modulation period is divided into 4 phase sampling intervals.
- On the CCD, 3 out of 4 rows are masked and the charges are shifted synchronously with the modulation period between the pixel rows (see figure) so that one charge reflects the accumulated intensity of one phase sampling interval on one pixel.
- **Polarimetric accuracy: $\sim 1\%$ for a single exposure and 10^{-5} by frame averaging (per pixel, on the solar disc)**

2. Measurement Method

with ZIMPOL II (*Zürich Imaging Stokes Polarimeter*)

ZIMPOL setup

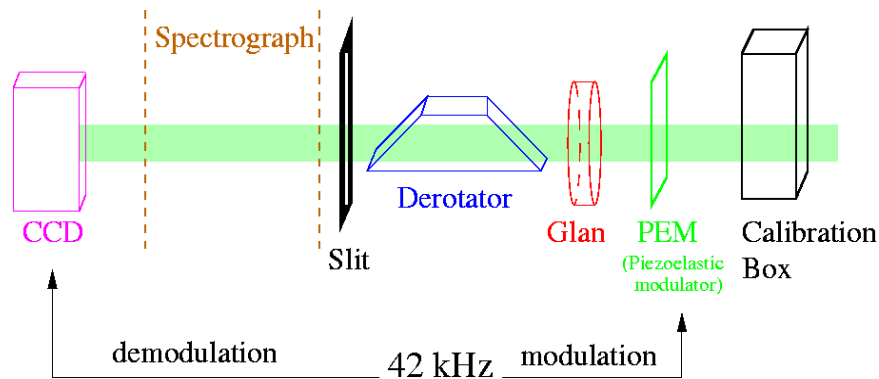

The demodulation technique

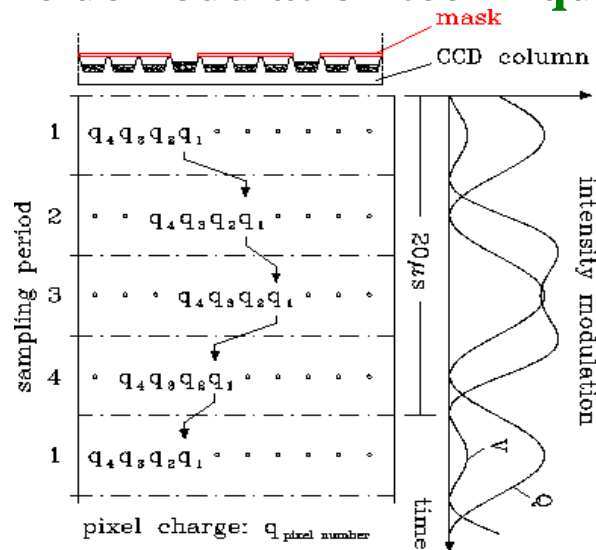

- 4 images with a different sensitivity to the polarisation states are generated using the same set of physical pixels → **the polarisation measurement is free from gain-table effects.**

- From the 4 images it is possible to extract the simultaneous 2-D information of the **circular polarization and one linear polarisation** component.

(ZIMPOL version with double FLC modulator allows the simultaneous measurement of **all 4 stokes** param..)

- The measurement of the **other linear polarisation** component is performed rotating PEM and Glan by 45° .
- The direction parallel to the solar limb is set parallel to the slit by help of the **derotator**, which follows automatically the image rotation induced by the telescope rotation.
- The **total intensity is reduced** with respect to the *beam-exchange technique*. (☹)

Data collection

1. Beam exchange technique:

- 24 Mar - 24 Apr 2003 (during 12 days)
- Typically we took a set of ~20 images of 5 sec exposure on a particular position on the prominences.
- Several set of images on different positions of the same prominence and at different time at the same position
- 19 prominences observed
- 918 exposures
- 57 sets of images

2. ZIMPOL2:

- 22 May - 7 Aug 2003 (during 9 days)
- Typically we took a set of ~100 images of ~10 sec exposure on a particular position on the prominences.
- Several set of images on different positions of the same prominence and at different time at the same position
- 11 prominences observed
- 2948 exposures
- 24 sets of images

+ Additional measurements at the center of the solar disc and in the halo near the prominence for correction purposes.

Data analysis

Correction for the instrumental polarization:

- The light from the **center** of the solar disc in a quiet region is assumed to be **unpolarized**.
- We measure frequently such light as **reference** for the instrumental polarization
- The **instrumental polarization** is subtracted from each polarization measurement of prominences.
- Special for the **beam exchange** technique:
 - The polarimetric measurements at the center of the solar disc shows an **interference pattern** which is subtracted from each measurement of prominences
 - The **direction** of the average instrumental linear polarization is calculated since it changes with time:

$$\left\{ \frac{Q}{I} \right\} = P_{lin} \sin(\pi - 2ha) \quad \left\{ \frac{U}{I} \right\} = -P_{lin} \cos(\pi - 2ha)$$

- **With ZIMPOL the change of direction of the instrumental polarization is indeed compensated by the derotator movement.**

Correction for the background light (halo):

- **The intensity profile outside the prominence in a quiet region of the halo (if it has been measured) or at the center of the solar disc, is scaled so that it fits the intensity profile outside the emission line. This is interpreted as the intensity profile of the background I_{bak}**

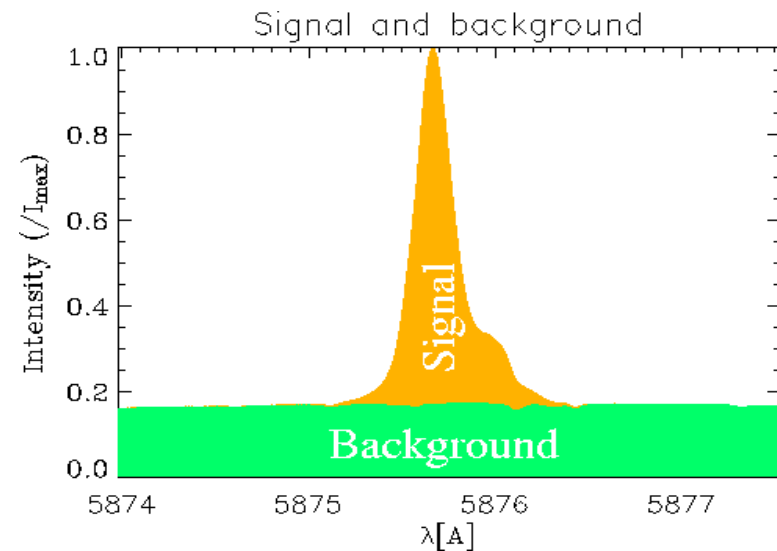

- Unfortunately we often notice a nonzero polarization outside the emission line. This has been noted to increase when the halo intensity decreases and to depend on the position on the Sun (high on NW region above solar limb). Therefore we interpret this as a **spurious polarization** signal from uncontrolled reflection light.

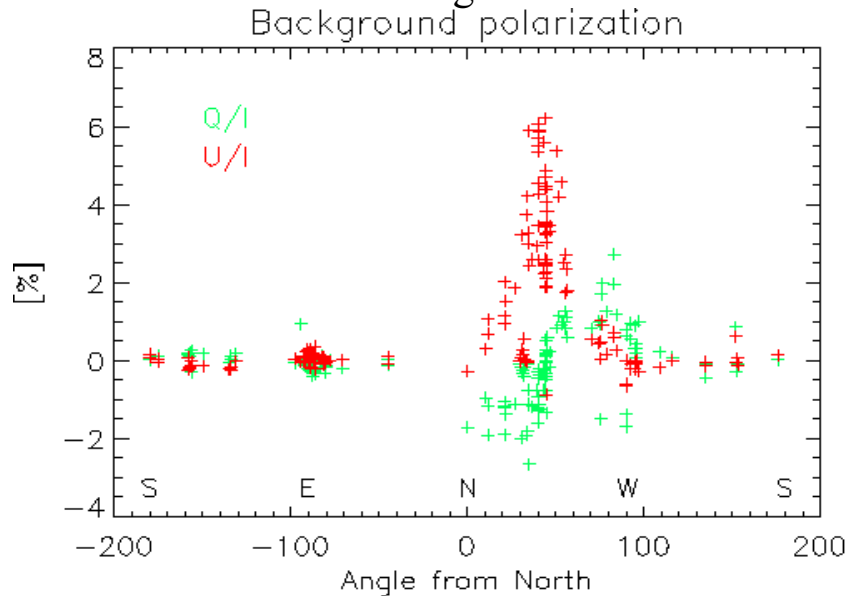

Example of Stokes 2D-Images of prominence measurement (ZIMPOL)

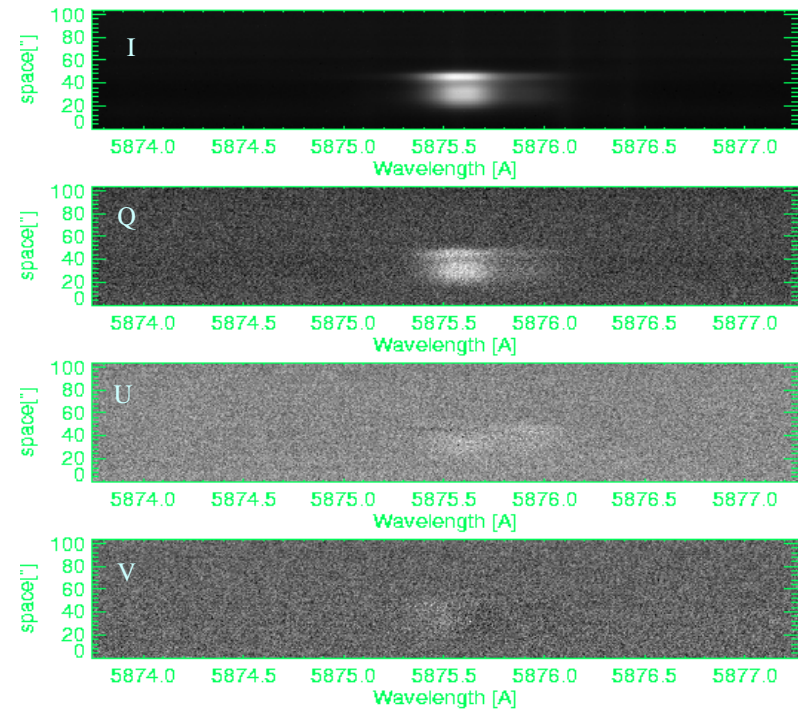

- The polarization of the emission signal is calculated as

$$Q_{\text{sig}} = \frac{Q}{I_{\text{sig}}} \quad \cdot I_{\text{mask}} = \frac{Q}{I_{\text{sig}}} \cdot I_{\text{bak}}$$

$$U_{\text{sig}} = \frac{U}{I_{\text{sig}}} \quad \cdot U_{\text{mask}} = \frac{U}{I_{\text{sig}}} \cdot I_{\text{bak}}$$

$$V_{\text{sig}} = \frac{V}{I_{\text{sig}}} \quad \cdot V_{\text{mask}} = \frac{V}{I_{\text{sig}}} \cdot I_{\text{bak}}$$

Selection of emission region

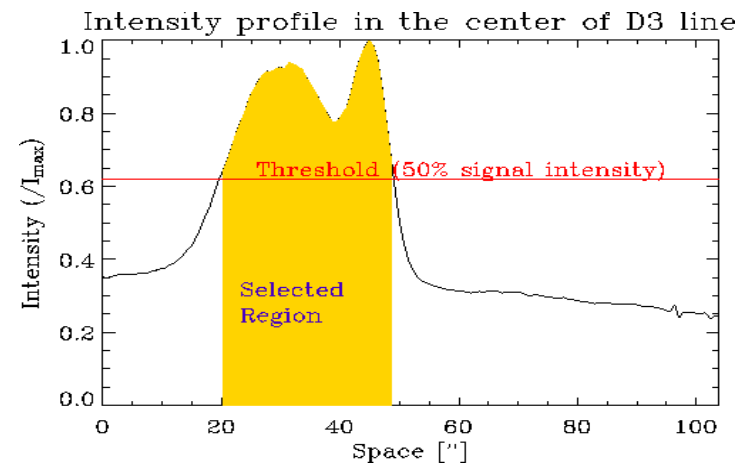

Examples of measured polarization profiles

1. Beam exchange technique

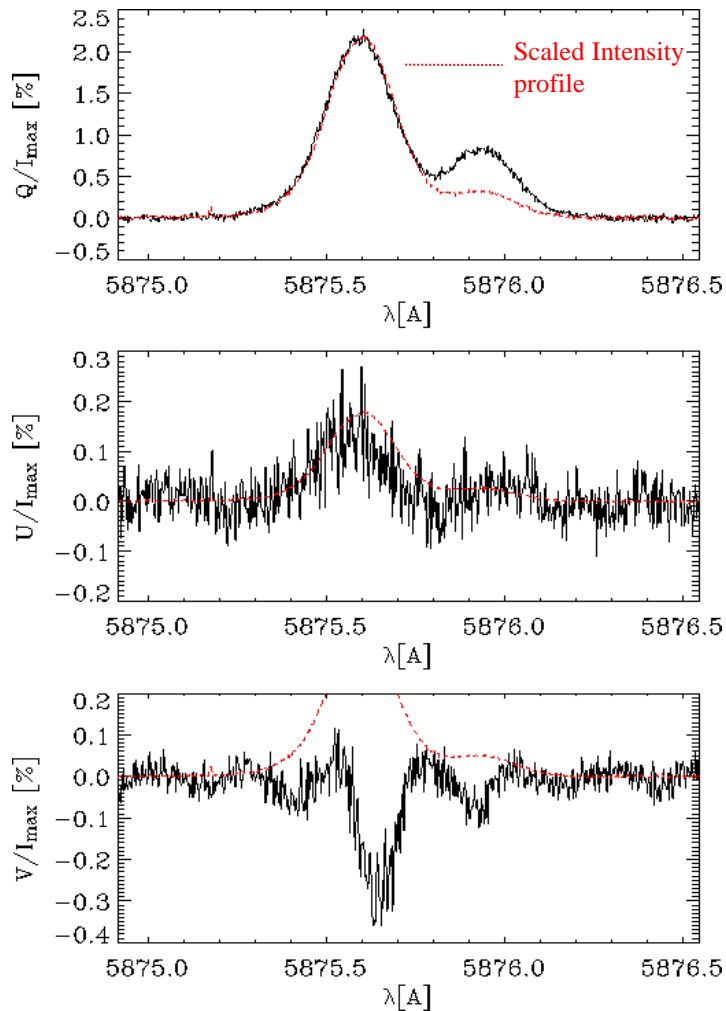

2. ZIMPOL

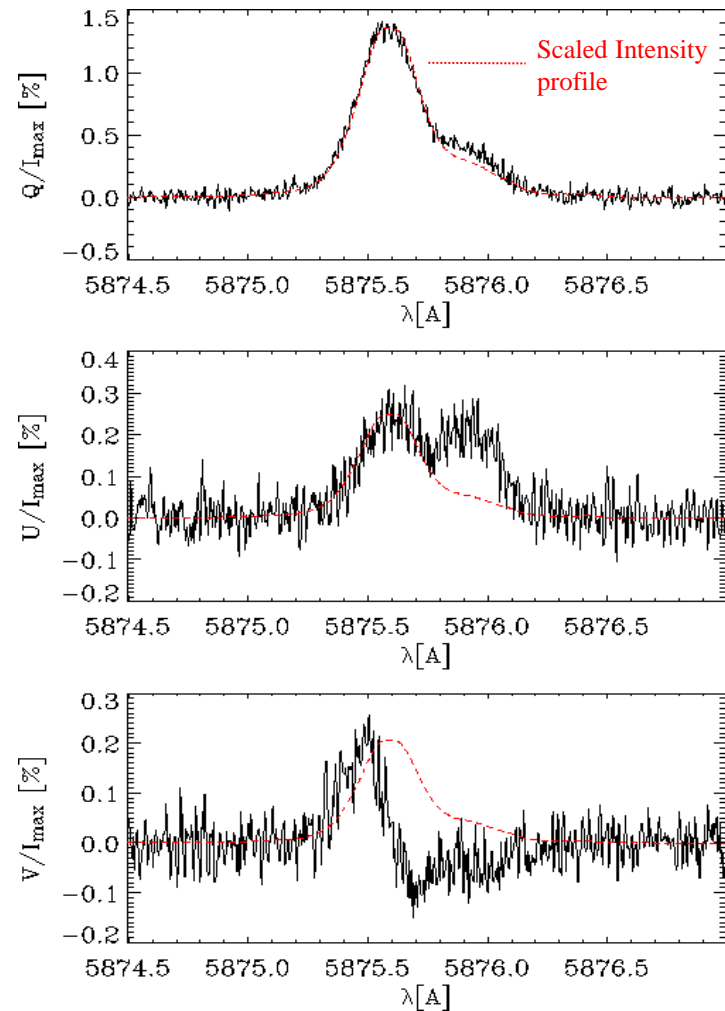

Some preliminary results

Comparison between blue component and red component of the D3 line.

We consider:

•As polarization of blue component (strong):

the average value in the interval 5875.5-5875.7Å

•As polarization of red component (weak):

the average value in the interval 5875.9-5876.0Å

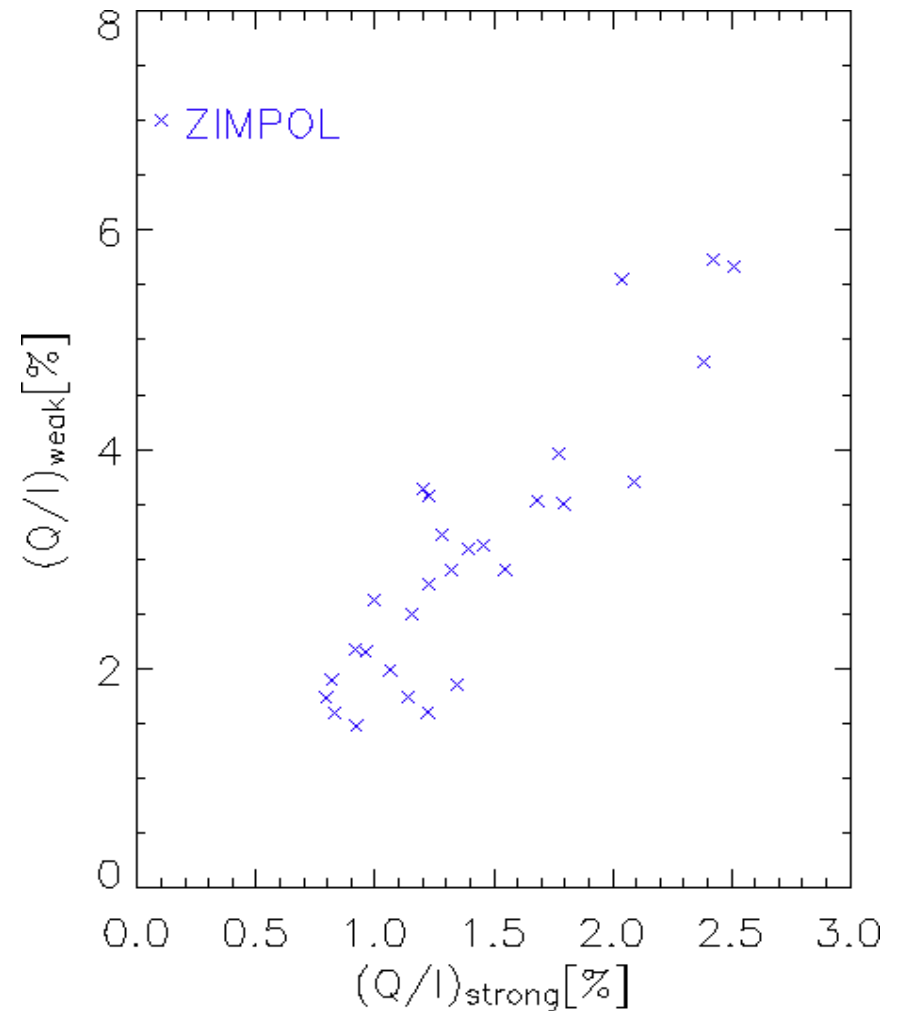

Some preliminary results

Comparison between blue component and red component of the D3 line.

We consider:

•As polarization of blue component (strong):

the average value in the interval 5875.5-5875.7Å

•As polarization of red component (weak):

the average value in the interval 5875.9-5876.0Å

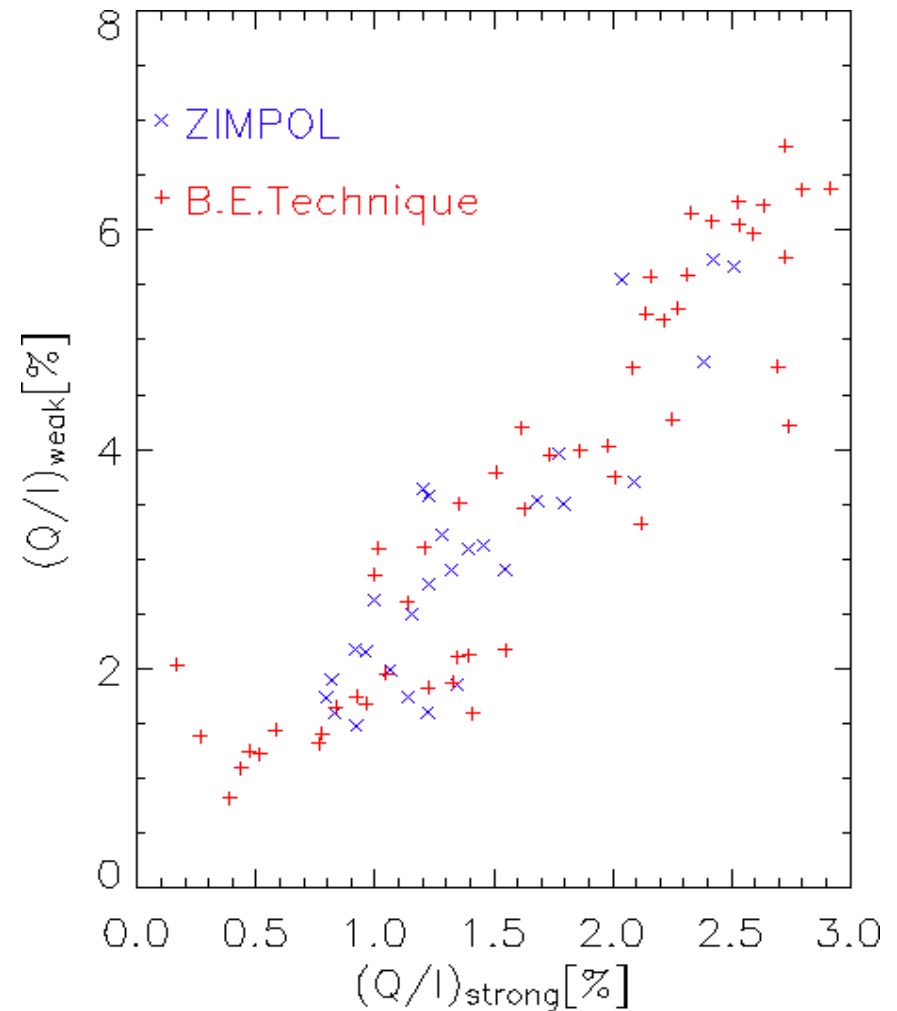

**Total linear polarization versus
polarization rotation angle
(Hanle-diagram)**

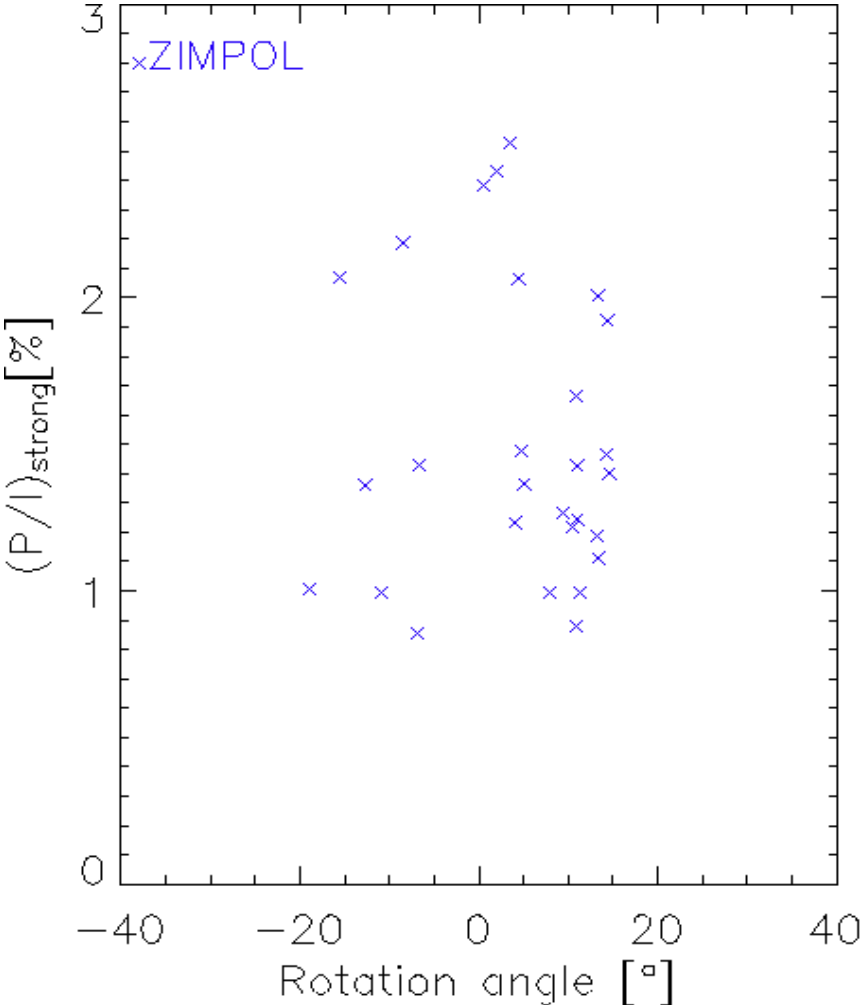

**Total linear polarization versus
polarization rotation angle
(Hanle-diagram)**

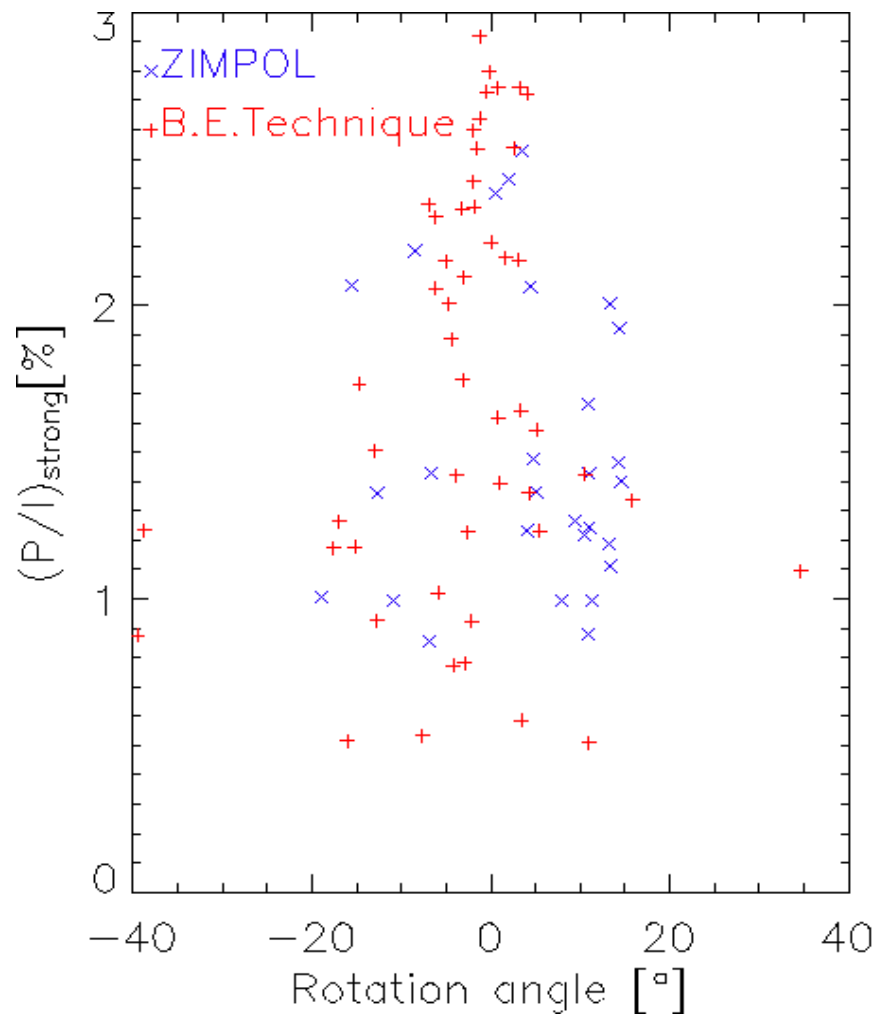

Total linear polarization versus polarization rotation angle (Hanle-diagram)

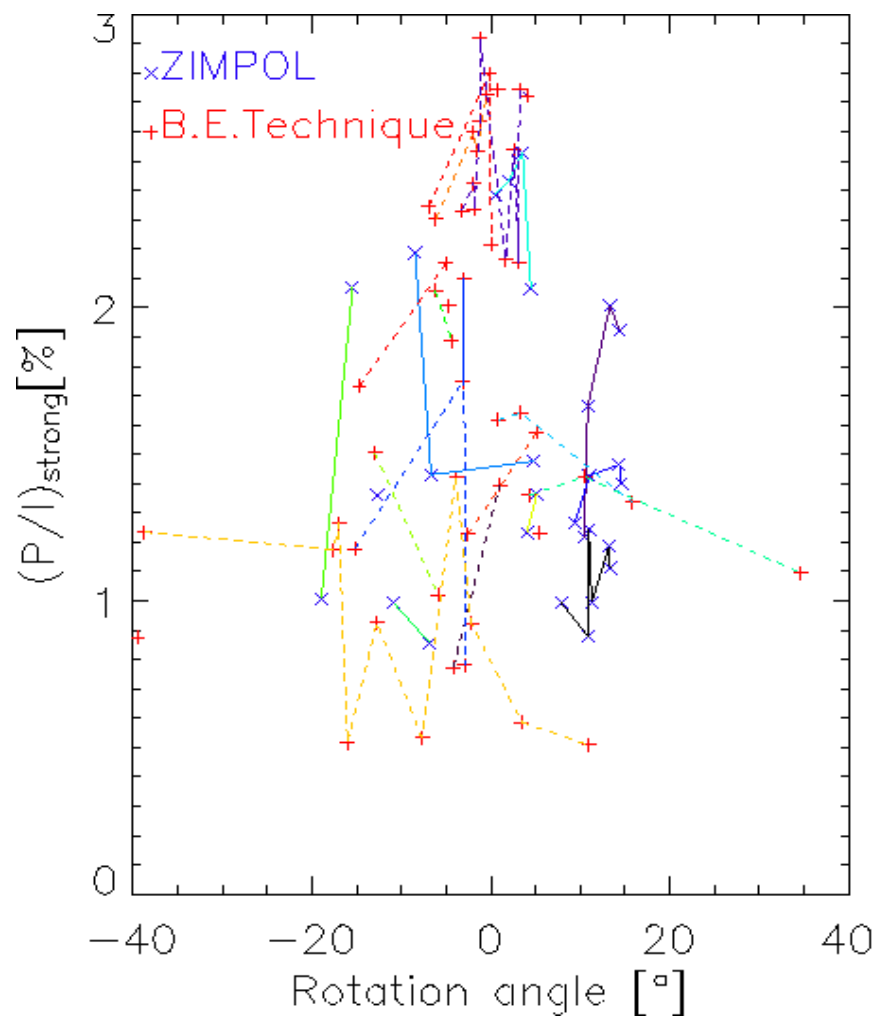

Stokes Q of the strong component versus limb distance. (ZIMPOL Data)

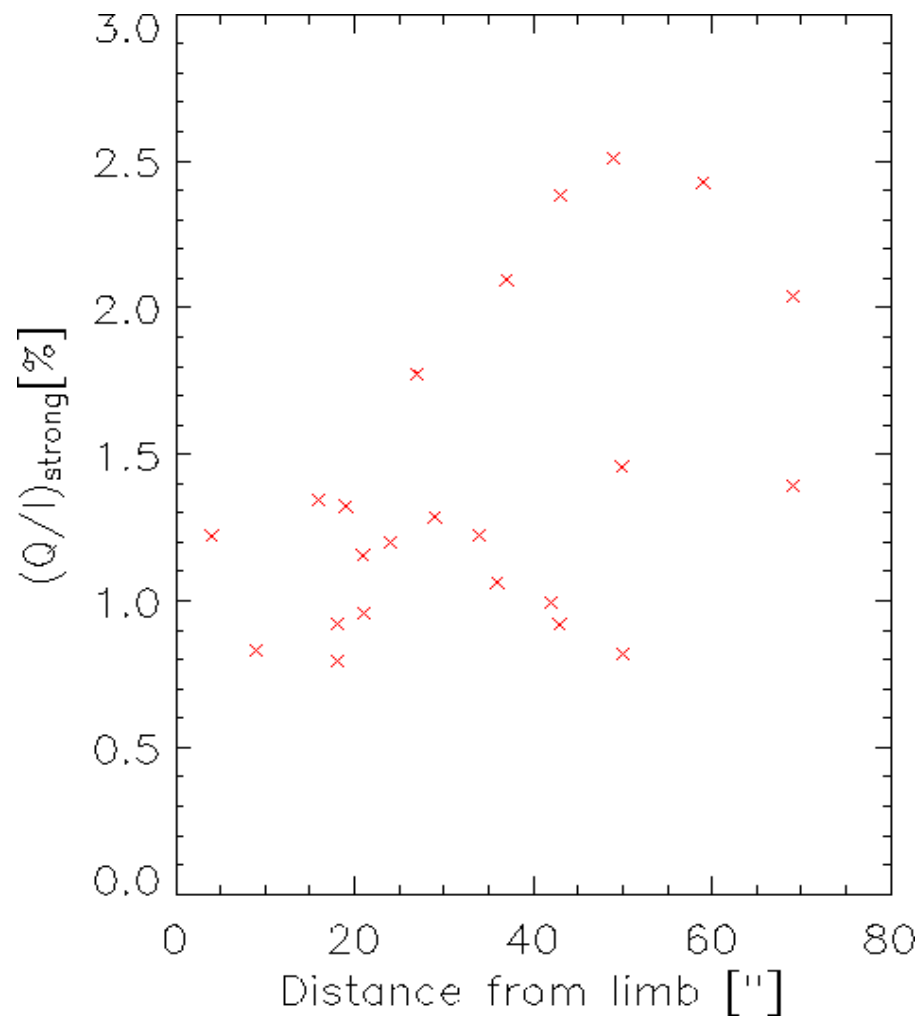

..... Measurements of the same prominence (in different locations)

**Total linear polarization versus polarization rotation angle
(Hanle-diagram)**

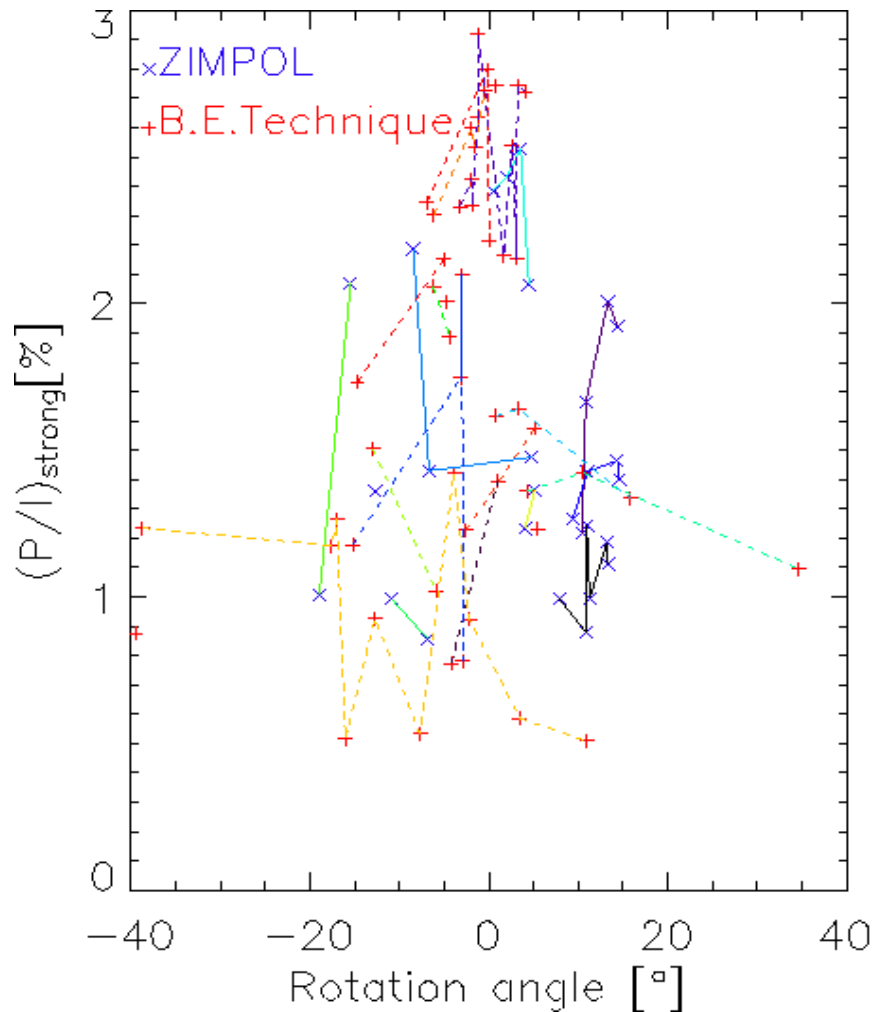

..... Measurements of the same prominence
(in different locations)

**Stokes Q of the strong component
versus limb distance.
(ZIMPOL Data)**

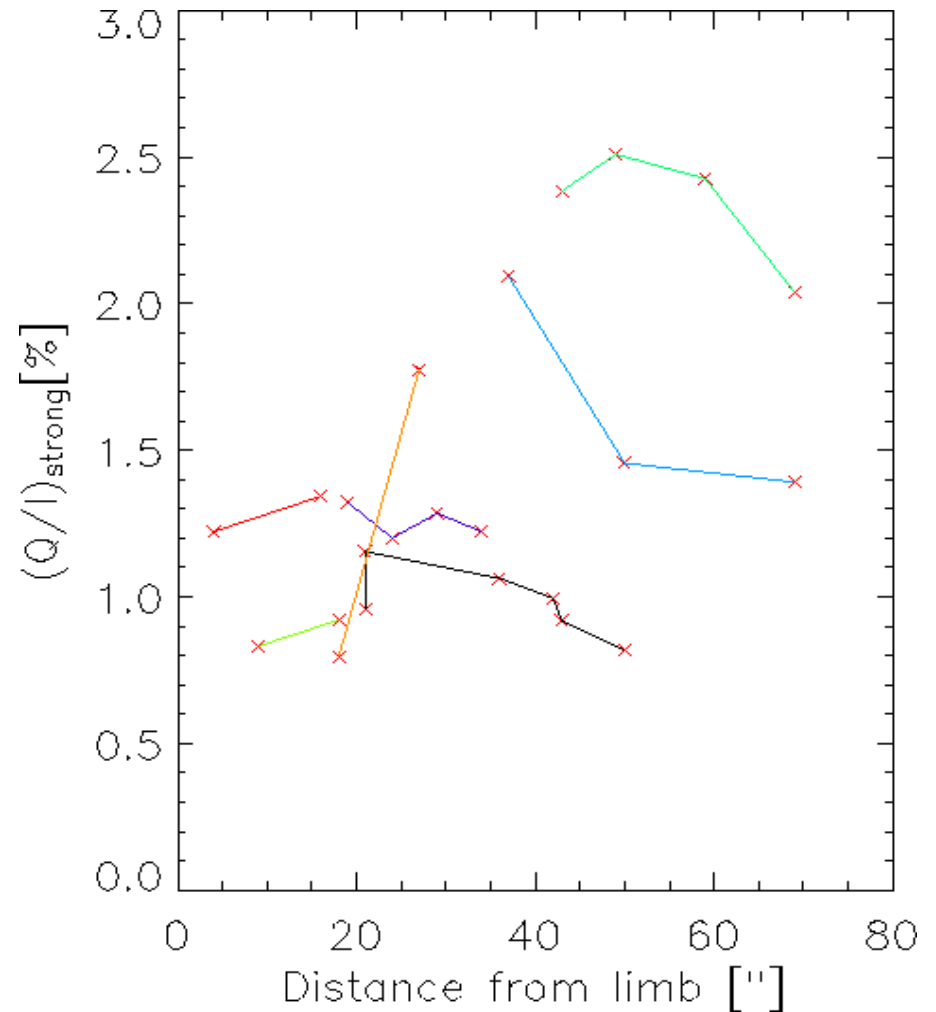

..... Measurements of the same prominence
(in different locations)

Conclusion

- At IRSOL the polarization measurement of 30 prominences with 2 different techniques has been performed.
- We presented the 2 measurement methods together with selected preliminary results.
- The 2 techniques give compatible results.
- Stokes Q shows always positive values up to 3% in the strong blue component and up to 7% in the faint red component (linear relation between the 2 comp.)
- $|U/I| < 1.5\%$ $|V/I| < 0.5\%$
- Next goals:
 - Physical interpretation of the results (magnetic field determination)
 - Extend the measurements to other emission lines (H_{α})
 - Cross-talk correction (in particular $Q \rightarrow V$)
 - Increase further the statistics